



Linde Material Handling

*Linde*



## Electric Counterbalance Truck

# X20 – X35

Capacity 2.0–3.5 t | Series 1252

### Electrically powered front-runner

- The first electric forklift truck which combines the performance and durability of an IC truck with dynamics, flexibility, and freedom from emissions that comes with an electric forklift truck
- Synchronous reluctance motor (SRM+) with efficient water-cooling system that allows for top-performance in multishift applications, even in extreme conditions like dust and dirt
- Highest standards when it comes to efficiency, ergonomics, and safety
- Optimally prepared for embedding within digital logistic processes thanks to data transmission unit fitted as standard

# TECHNICAL DATA (According to VDI 2198)

Characteristics	1.1	Manufacturer		Linde	Linde	Linde	Linde
	1.2	Manufacturer's type designation		X20 / 600	X25	X30	X35
	1.2 a	Series		1252-01	1252-01	1252-01	1252-01
	1.3	Power unit		Battery	Battery	Battery	Battery
	1.4	Operation		Seat	Seat	Seat	Seat
	1.5	Load capacity/Load	Q (t)	2.0	2.5	3.0	3.5
	1.6	Load centre distance	c (mm)	600	500	500	500
	1.8	Axle centre to fork face	x (mm)	455.5	455.5	448.5	453.5
	1.9	Wheelbase	y (mm)	1835	1835	1875	1875
Weights	2.1	Service weight	kg	4837 <sup>1)</sup>	4837 <sup>1)</sup>	5121 <sup>1)</sup>	5536 <sup>1)</sup>
	2.2	Axle load with load, front/rear	kg	5663/1174	6315/1022	7104/1017	7953/1083
	2.3	Axle load without load, front/rear	kg	2513/2324 <sup>1)</sup>	2513/2324 <sup>1)</sup>	2586/2535 <sup>1)</sup>	2673/2863 <sup>1)</sup>
Wheels/Tyres	3.1	Tyres rubber, SE, pneumatic, polyurethane		SE	SE	SE	SE
	3.2	Tyre size, front		250 / 75-12 (27x10-12)	250 / 75-12 (27x10-12)	250 / 75-12 (27x10-12)	355 / 45-15 (28x12.5-15)
	3.3	Tyre size, rear		6.50-10	6.50-10	225 / 75-10 (23x9-10)	225 / 75-10 (23x9-10)
	3.5	Wheels, number front/rear (x = driven)		2x / 2	2x / 2	2x / 2	2x / 2
	3.6	Track width, front	b10 (mm)	1008	1008	1008	1060
	3.7	Track width, rear	b11 (mm)	946	946	930	930
	Dimensions	4.1	Mast/fork carriage tilt, forward/backward	a / b (°)	5.0 / 8.0	5.0 / 8.0	5.0 / 8.0
4.2		Height of mast, lowered	h1 (mm)	2220	2220	2218	2224
4.3		Free lift	h2 (mm)	150	150	150	150
4.4		Lift	h3 (mm)	3095	3095	3095	3095
4.5		Height of mast, extended	h4 (mm)	3852	3852	3850	3856
4.7		Height of overhead guard (cabin)	h6 (mm)	2225	2225	2225	2225
4.8		Seat height relating to SIP/stand height	h7 (mm)	1156	1156	1162	1162
4.12		Towing coupling height	h10 (mm)	587	587	598	600
4.19		Overall length	l1 (mm)	3671	3671	3704	3709
4.20		Length to fork face	l2 (mm)	2671	2671	2704	2709
4.21		Overall width	b1 / b2 (mm)	1256	1256	1256	1356
4.22		Fork dimensions DIN ISO 2331	s / e / l (mm)	45 × 100 × 1000	45 × 100 × 1000	45 × 100 × 1000	50 × 120 × 1000
4.23		Fork carriage to ISO 2328, class/type A, B		2A	2A	3A	3A
4.24		Width of fork carriage	b3 (mm)	1150	1150	1150	1150
4.31		Ground clearance, below mast	m1 (mm)	119	119	117	124
4.32		Ground clearance, centre of wheelbase	m2 (mm)	173	173	178	180
4.34.1		Aisle width for pallets 1000 × 1200 crossways	Ast (mm)	4008 <sup>2)</sup>	4008 <sup>2)</sup>	4043 <sup>2)</sup>	4048 <sup>2)</sup>
4.34.2		Aisle width with pallet 800 × 1200 along forks	Ast (mm)	4208 <sup>2)</sup>	4208 <sup>2)</sup>	4243 <sup>2)</sup>	4248 <sup>2)</sup>
4.35		Turning radius	Wa (mm)	2352	2352	2394	2394
4.36		Minimum pivoting point distance	b13 (mm)	655	655	668	668
Performance	5.1	Travel speed, with/without load	km/h	22 / 22	22 / 22	22 / 22	22 / 22
	5.2	Lifting speed, with/without load	m/s	0.56 / 0.58	0.57 / 0.58	0.57 / 0.58	0.54 / 0.58
	5.3	Lowering speed, with/without load	m/s	0.58 / 0.57	0.58 / 0.57	0.58 / 0.57	0.58 / 0.57
	5.5	Tractive force, with/without load	N	7600 / 7600	7600 / 7600	7600 / 7600	7600 / 7600
	5.6	Maximum tractive force, with/without load	N	20000 / 20000	20000 / 20000	20000 / 20000	20000 / 20000
	5.7	Climbing ability, with/without load	%	22.2 / 33.2	20.5 / 33.2	18.3 / 31.2	17.6 / 27.2
	5.8	Maximum climbing ability, with/without load	%	28.7 / 43.4	26.4 / 43.4	23.6 / 40.6	19.9 / 35.3
	5.9	Acceleration time, with/without load	s	4.8 / 4.3	4.9 / 4.3	5.1 / 4.3	5.3 / 4.4
	5.10	Service brake		hydr. / mech.	hydr. / mech.	hydr. / mech.	hydr. / mech.
	Drive	6.1	Drive motor rating S2 60 min	kW	2x 12.4	2x 12.4	2x 12.4
6.2		Lift motor rating at S3 15 %	kW	20	20	20	20
6.3		Battery according to DIN 43531 / 35 / 36 A, B, C, no		Li-ION	Li-ION	Li-ION	Li-ION
6.4		Battery voltage / rated capacity (5 h)	(V) / (Ah)	90 / 670	90 / 670	90 / 670	90 / 670
6.4.a		Battery energy content	kWh	42.88	42.88	42.88	42.88
6.5		Battery weight (± 5 %)	kg	1210	1210	1210	1210
6.6		Energy consumption according to DIN EN 16796	kWh/h	6.1	6.5	7	7.3
6.6.1		CO2 equivalent according to EN 16796	kg/h	3.3	3.5	3.8	3.9
6.7		Turnover output according to VDI 2198	t/h	159.0	198.0	235.0	272.0
6.8	Turnover efficiency according to VDI 2198	t / kWh	16.9	20.2	22.8	26.1	
Others	8.1	Type of drive unit		Digital / stepless	Digital / stepless	Digital / stepless	Digital / stepless
	10.1	Operating pressure for attachments	bar	180	200	225	245
	10.2	Oil flow for attachments	/ min	50	50	50	50
	10.7	Sound pressure level LpAZ (at the driver's seat)	dB (A)	<65	<65	<65	<65
	10.8	Towing coupling, design/type, DIN 15 170		similar to form H	similar to form H	similar to form H	similar to form H
11.2	Static stability		2.02	1.79	1.67	1.61	

1) Figures with battery, see line 6.4/6.5.

2) Including a 200 mm (min.) operating aisle clearance.

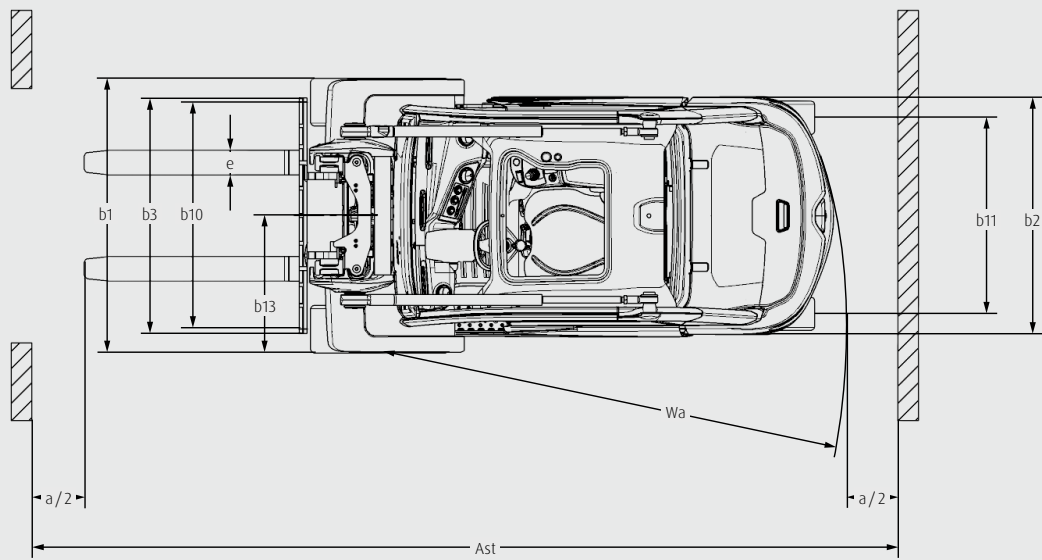
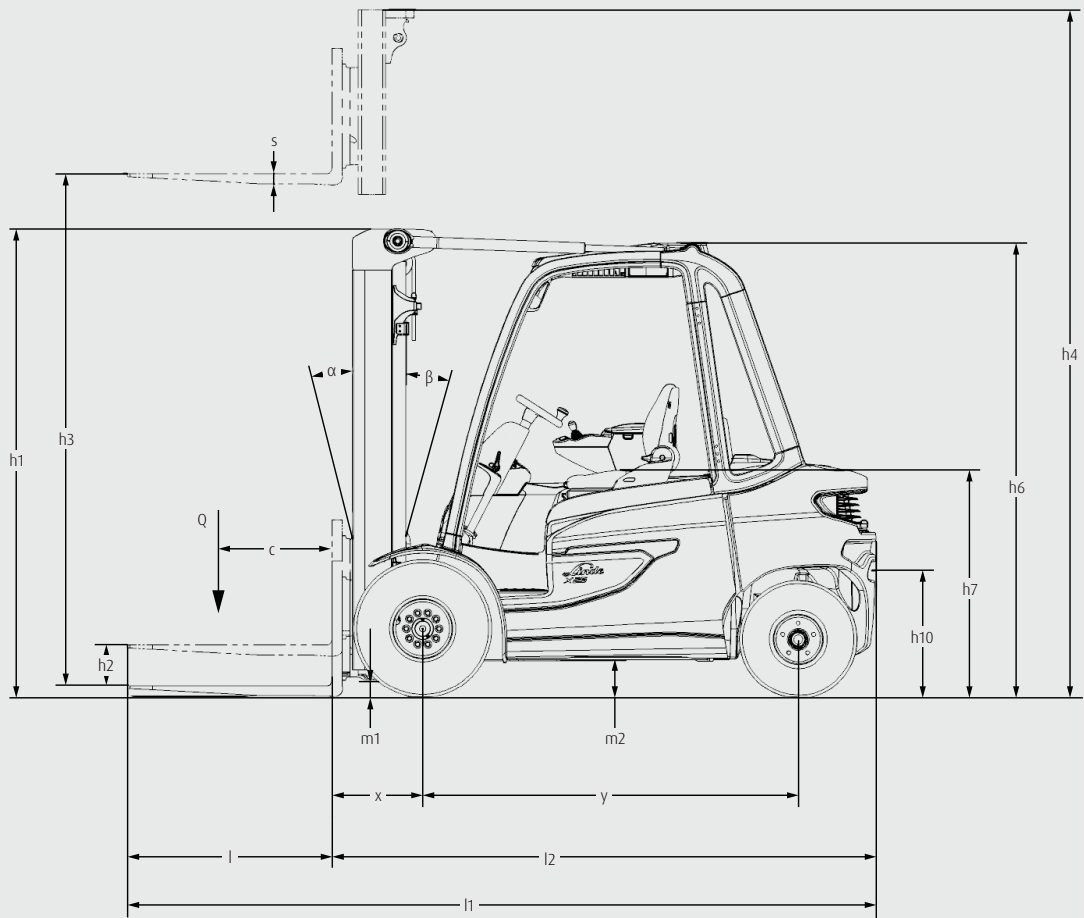

# MAST TABLES

## STANDARD MAST (in mm)

Series	1533													
Lift	h3: 3095		h3: 3295		h3: 3395		h3: 3695		h3: 3995		h3: 4195		h3: 4495	
Height measurements	h1: 2225	h2: 150	h1: 2325	h2: 150	h1: 2375	h2: 150	h1: 2525	h2: 150	h1: 2675	h2: 150	h1: 2775	h2: 150	h1: 2925	h2: 150
Model	h4: 3856	h4: 4056	h4: 4156	h4: 4456	h4: 4756	h4: 4956	h4: 5256							
X20 / 600	<input type="radio"/>	<input type="radio"/>	<input type="radio"/>	<input type="radio"/>	<input type="radio"/>	<input type="radio"/>	<input type="radio"/>	<input type="radio"/>	<input type="radio"/>	<input type="radio"/>	<input type="radio"/>	<input type="radio"/>	<input type="radio"/>	<input type="radio"/>
X25	<input type="radio"/>	<input type="radio"/>	<input type="radio"/>	<input type="radio"/>	<input type="radio"/>	<input type="radio"/>	<input type="radio"/>	<input type="radio"/>	<input type="radio"/>	<input type="radio"/>	<input type="radio"/>	<input type="radio"/>	<input type="radio"/>	<input type="radio"/>
X30	<input type="radio"/>	<input type="radio"/>	<input type="radio"/>	<input type="radio"/>	<input type="radio"/>	<input type="radio"/>	<input type="radio"/>	<input type="radio"/>	<input type="radio"/>	<input type="radio"/>	<input type="radio"/>	<input type="radio"/>	<input type="radio"/>	<input type="radio"/>
X35	<input type="radio"/>	<input type="radio"/>	<input type="radio"/>	<input type="radio"/>	<input type="radio"/>	<input type="radio"/>	<input type="radio"/>	<input type="radio"/>	<input type="radio"/>	<input type="radio"/>	<input type="radio"/>	<input type="radio"/>	<input type="radio"/>	<input type="radio"/>
X20 / 600 Container	<input type="radio"/>	<input type="radio"/>	<input type="radio"/>	<input type="radio"/>	<input type="radio"/>	<input type="radio"/>	<input type="radio"/>	<input type="radio"/>	<input type="radio"/>	<input type="radio"/>	<input type="radio"/>	<input type="radio"/>	<input type="radio"/>	<input type="radio"/>
X25 Container	<input type="radio"/>	<input type="radio"/>	<input type="radio"/>	<input type="radio"/>	<input type="radio"/>	<input type="radio"/>	<input type="radio"/>	<input type="radio"/>	<input type="radio"/>	<input type="radio"/>	<input type="radio"/>	<input type="radio"/>	<input type="radio"/>	<input type="radio"/>
X30 Container	<input type="radio"/>	<input type="radio"/>	<input type="radio"/>	<input type="radio"/>	<input type="radio"/>	<input type="radio"/>	<input type="radio"/>	<input type="radio"/>	<input type="radio"/>	<input type="radio"/>	<input type="radio"/>	<input type="radio"/>	<input type="radio"/>	<input type="radio"/>
X35 Container	<input type="radio"/>	<input type="radio"/>	<input type="radio"/>	<input type="radio"/>	<input type="radio"/>	<input type="radio"/>	<input type="radio"/>	<input type="radio"/>	<input type="radio"/>	<input type="radio"/>	<input type="radio"/>	<input type="radio"/>	<input type="radio"/>	<input type="radio"/>

## DUPLEX MAST (in mm)

Series	1533				
Lift	h3: 3165	h3: 3265	h3: 3365	h3: 3465	h3: 3765
Height measurements	h1: 2180	h1: 2230	h1: 2280	h1: 2330	h1: 2480
Model	h2: 1395	h2: 1445	h2: 1495	h2: 1545	h2: 1695
Model	h4: 3951	h4: 4051	h4: 4151	h4: 4251	h4: 4551
X20 / 600	<input type="radio"/>	<input type="radio"/>	<input type="radio"/>	<input type="radio"/>	<input type="radio"/>
X25	<input type="radio"/>	<input type="radio"/>	<input type="radio"/>	<input type="radio"/>	<input type="radio"/>
X30	<input type="radio"/>	<input type="radio"/>	<input type="radio"/>	<input type="radio"/>	<input type="radio"/>
X35	<input type="radio"/>	<input type="radio"/>	<input type="radio"/>	<input type="radio"/>	<input type="radio"/>
X20 / 600 Container	<input type="radio"/>	<input type="radio"/>	<input type="radio"/>	<input type="radio"/>	<input type="radio"/>
X25 Container	<input type="radio"/>	<input type="radio"/>	<input type="radio"/>	<input type="radio"/>	<input type="radio"/>
X30 Container	<input type="radio"/>	<input type="radio"/>	<input type="radio"/>	<input type="radio"/>	<input type="radio"/>
X35 Container	<input type="radio"/>	<input type="radio"/>	<input type="radio"/>	<input type="radio"/>	<input type="radio"/>

## TRIPLEX MAST (in mm)

Series	1533															
Lift	h3: 4680		h3: 4830		h3: 4980		h3: 5130		h3: 5330		h3: 5480		h3: 5930		h3: 6580	
Height measurements	h1: 2180	h2: 1395	h1: 2230	h2: 1445	h1: 2280	h2: 1495	h1: 2330	h2: 1545	h1: 2430	h2: 1645	h1: 2480	h2: 1695	h1: 2630	h2: 1845	h1: 2880	h2: 2095
Model	h4: 5473	h4: 5623	h4: 5773	h4: 5923	h4: 6123	h4: 6273	h4: 6723	h4: 6873	h4: 7373	h4: 7523	h4: 7673	h4: 7823	h4: 8323	h4: 8473	h4: 8973	h4: 9123
X20 / 600	<input type="radio"/>	<input type="radio"/>	<input type="radio"/>	<input type="radio"/>	<input type="radio"/>	<input type="radio"/>	<input type="radio"/>	<input type="radio"/>	<input type="radio"/>	<input type="radio"/>	<input type="radio"/>	<input type="radio"/>	<input type="radio"/>	<input type="radio"/>	<input type="radio"/>	<input type="radio"/>
X25	<input type="radio"/>	<input type="radio"/>	<input type="radio"/>	<input type="radio"/>	<input type="radio"/>	<input type="radio"/>	<input type="radio"/>	<input type="radio"/>	<input type="radio"/>	<input type="radio"/>	<input type="radio"/>	<input type="radio"/>	<input type="radio"/>	<input type="radio"/>	<input type="radio"/>	<input type="radio"/>
X30	<input type="radio"/>	<input type="radio"/>	<input type="radio"/>	<input type="radio"/>	<input type="radio"/>	<input type="radio"/>	<input type="radio"/>	<input type="radio"/>	<input type="radio"/>	<input type="radio"/>	<input type="radio"/>	<input type="radio"/>	<input type="radio"/>	<input type="radio"/>	<input type="radio"/>	<input type="radio"/>
X35	<input type="radio"/>	<input type="radio"/>	<input type="radio"/>	<input type="radio"/>	<input type="radio"/>	<input type="radio"/>	<input type="radio"/>	<input type="radio"/>	<input type="radio"/>	<input type="radio"/>	<input type="radio"/>	<input type="radio"/>	<input type="radio"/>	<input type="radio"/>	<input type="radio"/>	<input type="radio"/>
X20 / 600 Container	<input type="radio"/>	<input type="radio"/>	<input type="radio"/>	<input type="radio"/>	<input type="radio"/>	<input type="radio"/>	<input type="radio"/>	<input type="radio"/>	<input type="radio"/>	<input type="radio"/>	<input type="radio"/>	<input type="radio"/>	<input type="radio"/>	<input type="radio"/>	<input type="radio"/>	<input type="radio"/>
X25 Container	<input type="radio"/>	<input type="radio"/>	<input type="radio"/>	<input type="radio"/>	<input type="radio"/>	<input type="radio"/>	<input type="radio"/>	<input type="radio"/>	<input type="radio"/>	<input type="radio"/>	<input type="radio"/>	<input type="radio"/>	<input type="radio"/>	<input type="radio"/>	<input type="radio"/>	<input type="radio"/>
X30 Container	<input type="radio"/>	<input type="radio"/>	<input type="radio"/>	<input type="radio"/>	<input type="radio"/>	<input type="radio"/>	<input type="radio"/>	<input type="radio"/>	<input type="radio"/>	<input type="radio"/>	<input type="radio"/>	<input type="radio"/>	<input type="radio"/>	<input type="radio"/>	<input type="radio"/>	<input type="radio"/>
X35 Container	<input type="radio"/>	<input type="radio"/>	<input type="radio"/>	<input type="radio"/>	<input type="radio"/>	<input type="radio"/>	<input type="radio"/>	<input type="radio"/>	<input type="radio"/>	<input type="radio"/>	<input type="radio"/>	<input type="radio"/>	<input type="radio"/>	<input type="radio"/>	<input type="radio"/>	<input type="radio"/>

○ Optional equipment

– Not available

**h1:** Height of mast, lowered

**h2:** Free lift

**h3:** Lift

**h4:** Height of mast, extended

# LOAD CAPACITY

## X20 / 600

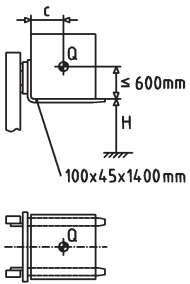

H (mm)	Q (kg)				
7000	1700	1550	1420	1320	
6900	1770	1620	1490	1380	
6800	1850	1680	1550	1440	
6700	1920	1750	1610	1490	
≤ 6600	2000	1820	1680	1550	
c (mm)	400 - 600	700	800	900	

## X25

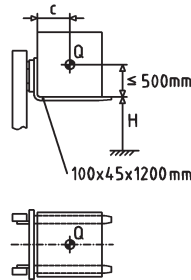

H (mm)	Q (kg)				
7000	1700	1530	1400	1290	
6900	1800	1620	1480	1370	
6800	1900	1720	1570	1440	
6700	2000	1810	1650	1520	
6600	2100	1900	1730	1590	
6500	2200	1990	1810	1670	
6400	2300	2080	1900	1750	
6300	2400	2170	1980	1820	
≤ 6200	2500	2260	2060	1900	
c (mm)	400 - 500	600	700	800	

## X30

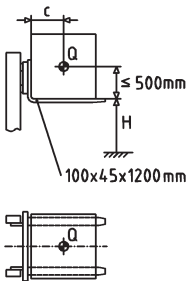

H (mm)	Q (kg)				
7000	2000	1800	1650	1510	
6900	2100	1890	1730	1590	
6800	2200	1990	1810	1670	
6700	2300	2080	1890	1740	
6600	2400	2170	1980	1820	
6500	2500	2260	2060	1890	
6400	2600	2350	2140	1970	
6300	2700	2440	2230	2050	
6200	2800	2530	2310	2120	
6100	2900	2620	2390	2200	
≤ 6000	3000	2710	2470	2270	
c (mm)	400 - 500	600	700	800	

## X35

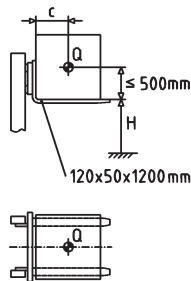

H (mm)	Q (kg)				
7000	2300	2080	1900	1740	
6900	2420	2190	2000	1840	
6800	2540	2290	2090	1930	
6700	2660	2400	2190	2020	
6600	2780	2510	2290	2110	
6500	2900	2620	2390	2200	
6400	3020	2730	2490	2290	
6300	3140	2840	2590	2380	
6200	3260	2950	2690	2480	
6100	3380	3050	2790	2570	
≤ 6000	3500	3160	2890	2660	
c (mm)	400 - 500	600	700	800	

H = Lifting height, c = Load centre, Q = Load capacity  
Load capacity for standard mast and fork carriage



# STANDARD AND OPTIONAL EQUIPMENT

		X20 - X35
Safety	Linde Curve Assist - automatic drive speed reduction when cornering	●
	Electrical seat belt monitoring - Visual and acoustic feedback	●
	Linde Load Assist - increased safety at high lift heights	●
	BlueSpot and TruckSpot - optical warning signal for pedestrians and drivers	○
	Load weight indicator	○
	Linde Safety Pilot - load-dependent travel and lifting speed intervention plus additional functions	○
	Linde Safety Guard - truck to truck warning and truck to pedestrian warning	○
	Speed limitations (via switch, indoor-outdoor, load depending)	○
	Restraint systems (different options)	○
	Lightning: LED Stripes	○
	Lightning: VertilLight	○
Motion Detection - registers movements in the back of the truck and prohibits the driving backwards	○	
Digitalisation	Data Transmission Online	●
	Data Transmission Wifi	○
	Linde connect:desk - local fleet management with different functional modules	○
	Linde connect:cloud - fleet management as a service (hosted version)	○
	Pre-Operation-Check - individualizable daily check protocol for operational readiness	○
Truck Call App - coordination of transport orders	○	
Operation/ Load Handling	Double pedal control - stepless acceleration and fast reversing	●
	Single pedal control - stepless acceleration	○
	Linde Load Control - central levers fully integrated in the armrest of precise control of all hydraulic functions	●
	Individual Lever System	○
Workplace	Innovative decoupling concept with ring bearings for lowest human vibrations	●
	Ergonomic and save truck access due to a low entry step and handle bar at a-pillar and bonnet	●
	Innovative decoupling concept for lowest human vibration	●
	Tilt adjustable steering column	●
	Overhead guard comfort for maximum head clearance	●
	Operator's seat - mechanical quick weight adjustment	●
	Various seating options such as heating, air suspension, active seat ventilation, longitudinal suspension	○
	Operator's seat - Swiveling seat	○
	Coloured 3.5" LED display with steering angle indicator, tilt angle indicator and remaining travel indicator	●
	Coloured 7" LED multifunction display integrates additional functions e.g. cameras and Linde Safety Pilot	○
	Top screen armored glass	○
	Alloy doors with openable window and door monitoring	○
	DIN A4 illuminated clipboard	○
	Fully integrated heater	○
	Fully integrated air conditioning inclusive defog function	○
Radio, DAB+, MP3 Player inclusive Bluetooth hands-free equipment	○	
Mast	Top mounted tilting cylinders - including maintenance free bearings	●
	Best visibility through asymmetric, nested mast profiles on standard, duplex, triplex mast	●
	Electronic damped tilt stop	●
	Hydraulic accumulator for high driving comfort and less wear	○
Attachment/ Forks	Reinforced Linde forks - easy adjustable and long life time	○
	Integrated sideshift with full lift capacity and roller guided	○
	Integrated fork positioner "view" for high residual capacities and optimized visibility	○
	Street sweeper preparation	○
Axles and Tyres	Super Elastic (SE) tyres	●
	Closed Shoulder Tyres CS 20	○
	Pneumatic tyres	○
	Antistatic, non marking tyres	○
	Anti-spray mudflaps front and rear	○
Drive and Brake-System	Two motor front wheel drive	●
	Synchronous reluctance motor (SRM+) for lift and drive function	●
	Power setting efficiency, economy, performance	●
	Automatic parking brake	●

● Standard equipment      ○ Optional equipment

# CHARACTERISTICS

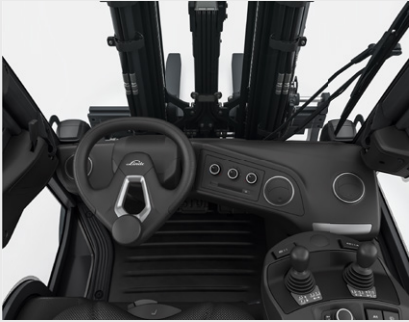

Driver workplace

## Ergonomics

- Spacious driver's cab and ergonomic seat ensure fatigue-free working
- Optimum view of both the load and surroundings
- Layout of control elements reduces the physical strain on the driver
- Separation of the workstation, drive unit, and mast reduces physical strain on the driver, including on uneven surfaces



Large tires and robust axle

## Handling

- A longer wheelbase, large tires, and vibration-free drive axle enable use in challenging environments
- Synchronous reluctance motor (SRM+) for lift and drive function with efficient water-cooling system ensures consistently high performance, even in extreme conditions
- Overhead tilt cylinder and warp-resistant mast design ensure safe load handling, even when storing and retrieving at height



All-round visibility

## Safety

- Chassis, A-pillar, mast, and roof construction provide the driver with optimum visibility of the load and surroundings
- The truck's low center of gravity reduces the risk of tipping
- Linde Curve Assist reduces speed in relation to the steering angle when cornering
- Linde Load Assist reduces the risk of tipping accidents when moving loads at height
- Automatic parking brake inclusive hill-hold function

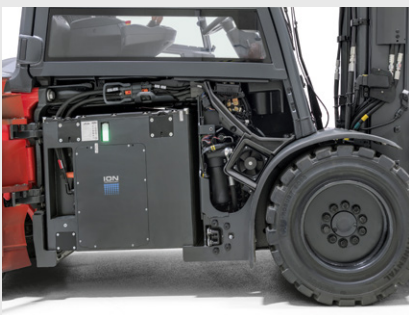

Easy service access

## Service

- Easy access to main components
- Driver display shows all important truck information to the driver
- Remote fault diagnosis and firmware updates can be conducted without a service technician, in turn saving costs
- Truck Health Monitoring enables comprehensive fault monitoring and faster fault localization wear and damage is identified early thus increasing truck availability
- Modular assemblies allow for quick replacement, shortening downtime during repairs
- Long service intervals e.g. 6000 h / 3 years hydraulic oil / filter change

Subject to modification in the interest of progress. Illustrations and technical details could include options and not binding for actual constructions. All dimensions subject to usual tolerances.



## Linde Material Handling GmbH

Carl-von-Linde-Platz | 63743 Aschaffenburg | Germany  
Phone + 49 6021 99 0 | Fax + 49 6021 99 1570  
www.linde-mh.com | info@linde-mh.com

Printed in Germany | 871.e.0,5.0621.lnd.a.se

Presented by:



Officina del Carrello  
di Vidoni Giuseppe S.r.l.  
T. +39 0432 600471  
E: info@officinadelcarrello.it  
www.officinadelcarrello.it

P. IVA e Cod. Fisc. IT01872940307  
Capitale sociale € 100.000,00 i.v.  
R.E.A. UD201577